

RECT-79 Series

7" x 9" Rectangular Lamps

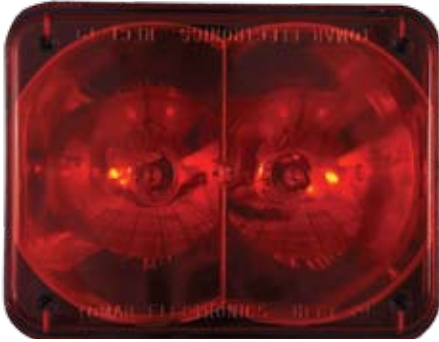

- 100% watertight
- extremely durable chrome reflector
- fits all popular emergency vehicles
- three year warranty on strobe version
- available in many color configurations

The RECT-79S series lamps are hermetically sealed and is 100% watertight. It is molded from Lexan® and has been designed to fit all popular emergency vehicles and can be used with any TOMAR strobe power supply or halogen controller. Its computer generated stepped optical design creates a hi efficiency reflector making it the brightest strobe light available from any manufacturer, and its hermetically sealed construction will keep it that way for a long time. The RECT-79 series lamps are furnished with a drill template, gasket, and mounting hardware.



RECT-79S
Single Strobe

The RECT-79S features a heavy duty linear flashtube. The stepped optical design creates a high efficiency reflector making it the brightest of all 7" x 9" models.



RECT-79SS
Dual Strobe

The RECT-79SS uses two flashtubes rated at 27 watts each. 54 watt power rating.



RECT-79HS
Halogen/Strobe

The RECT-79HS uses a replaceable #890 automotive 12V halogen lamp rated at 27 watts and a non-replaceable strobe lamp. 54 watts power rating.

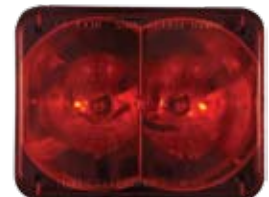

RECT-79H
Halogen

The RECT-79H uses two #890 automotive 12V halogen lamps rated at 27 watts each, which can be connected in series for use on 24V automotive systems.

RECT-79 SERIES LAMPS

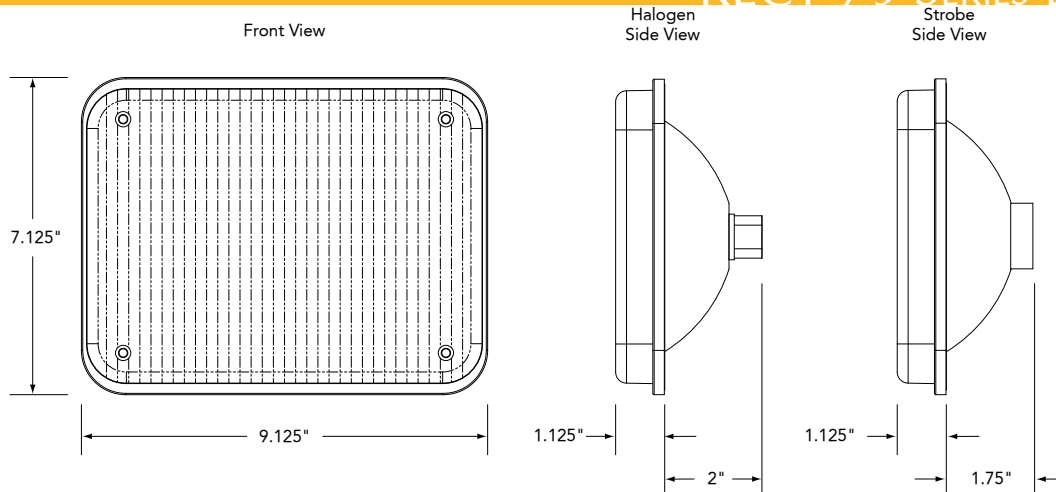

Available Lens Colors:



Amber

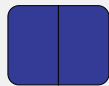

Blue

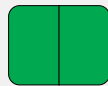

Green

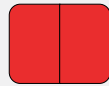

Red

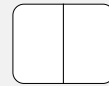

Clear

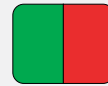

Green/Red

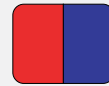

Red/Blue

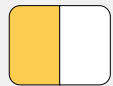

Amber/Clear

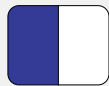

Blue/Clear

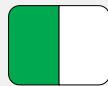

Green/Clear

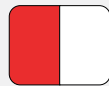

Red/Clear

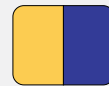

Amber/Blue



Amber/Red

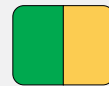

Green/Amber

Ordering Information

Please specify lens colors and model number when ordering.

Model No.	Description
RECT-79S	Strobe, 7" x 9" rectangular lamp
RECT-79SS	Dual Strobe, 7" x 9" rectangular lamp
RECT-79HS	Halogen/Strobe combination, 7" x 9" rectangular lamp
RECT-79H	Halogen, 7" x 9" rectangular lamp

Replacement Parts

Model No.	Description
930DM-FLASHER	Flashes 1 to 4 890's, 12VDC, solid state
890	27 watt, 12VDC halogen lamp
890-24	27 watt, 24VDC halogen lamp
890HP	37 watt, 12VDC halogen lamp
890-CONN	Watertight connector for lamp
889	27 watt, 12VDC halogen lamp with 90° angled socket base

Sharp Communication, Inc.
 3403 Governors Drive
 Huntsville, AL 35805
 800.548.2484
 256.533.2484
 www.SharpCom.com

See page C32-C33 for a complete list of available mounting accessories.